

Ezi-STEP[®]

Micro Stepping System

- **Micro Stepping with Integrated Drive**
- **Sensorless Stall Detection**
- **Software Damping**
- **Run / Stop Signal Output**

BT



CE

FASTECH

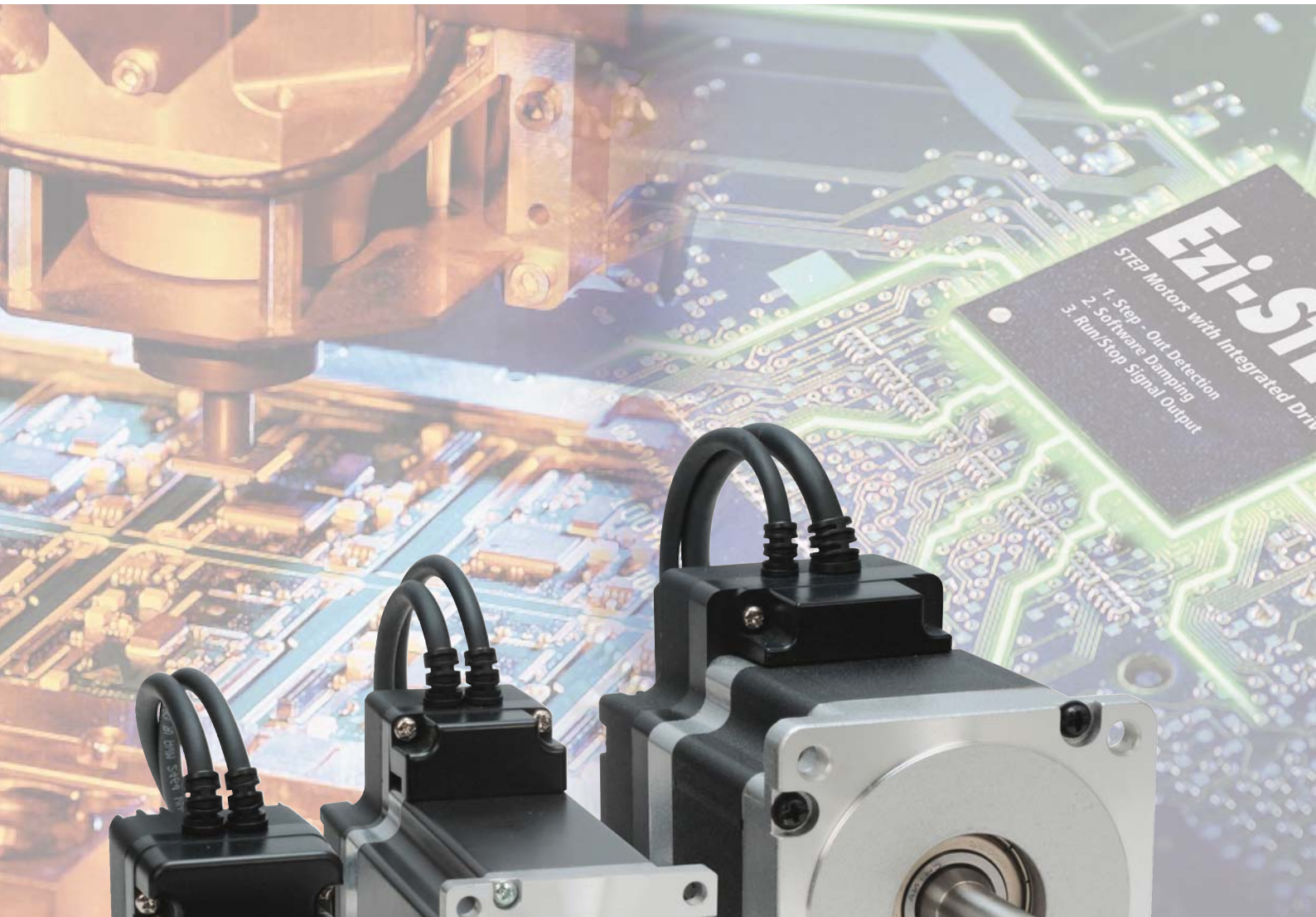

Ezi-STEP
STEP Motors with Integrated Drive
1. Step - Out Detection
2. Software Damping
3. Run/Stop Signal Output



Ezi-STEP[®] **BT**

Step Motors with Integrated Drive

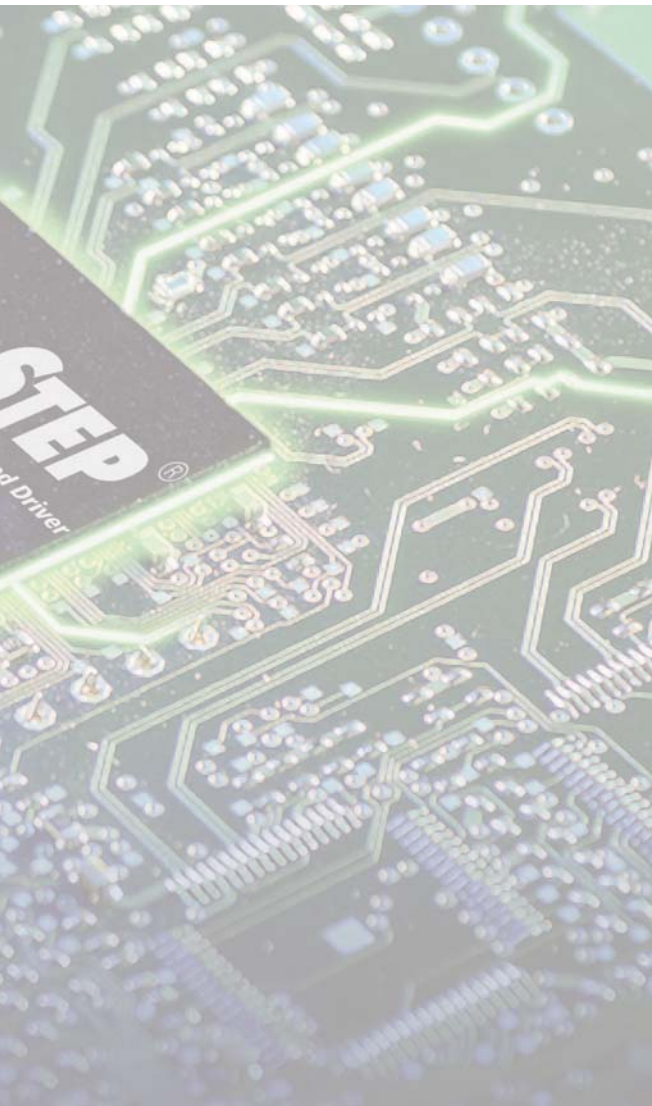

● Ezi-STEP Characteristics

Ezi-STEP[®] is a micro stepping system that incorporates a motor and DSP (Digital Signal Processor) equipped drive that is integrated seamlessly together as a system. This makes it possible to incorporate many functions compared with a conventional stepping motors and drives, such as sensorless detection of loss of synchronization, smooth control over the whole velocity range, higher torque operation and no vibration at the low speed range.

Ezi-STEP[®]'s on-board high-performance digital signal processor and proprietary algorithms allow the Ezi-STEP[®] to operate at high speeds with unmatched precision. The unique position estimation algorithm instantaneously detects out-of-synchronization based on the rotor position of the stepping motor, which is not an easy task in a conventional stepping motor and drives (effective only over 300 rpm.)

Utilizing a software damping and filtering algorithms, high speed operation is realized by the exciting angle control of a step-angle. The resolution of Ezi-STEP[®] can be selected from basic 1.8° up to 0.0072° (1/250). In addition, Ezi-STEP[®] generates various signals including sensorless stall detection, alarm and running signal. Ezi-STEP[®] is an economical ideal drive for vision systems, nanotech, packaging, semiconductor, pick and place, automation, laboratory testing, wood working and wherever smooth, quiet, precise, high torque operation is a requirement!

1. Sensorless Stall Detection
2. Software Damping
3. Run/Stop Signal Output



1 Sensorless Stall Detection

Detecting the loss-of-synchronization with on-board DSP(patent pending)

Ezi-STEP® can detect the loss-of-synchronization of a stepping motor without the addition of an external sensor. By monitoring the voltage, current, and back-emf signal, the on-board DSP estimates the current position of a rotor and enables it to detect the loss-of-synchronization (an impossible task for a conventional stepping motor drive), this allows for high-speed operation at 100% torque rating without loss-of-synchronization*.

*Effective only over 300 rpm

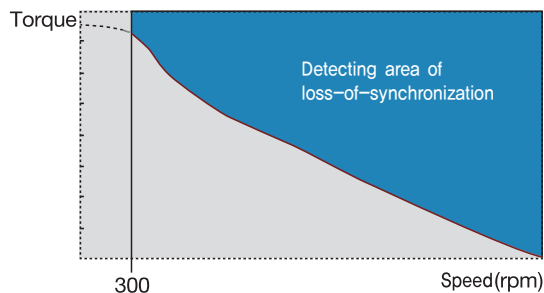

2 Microstep and Filtering

High precision Microstep function and Filtering (Patent pending)

The high-performance DSP operates at step resolutions of 1.8° up to maximum 0.0072° (1/250 steps) and Ezi-STEP® adjusts PWM control signal in every 25µ sec, which makes it possible for more precise current control, resulting in high-precision Microstep operation.

3 Software Damping

Vibration suppression and high-speed operation (Patent pending)

Vibration suppression and High-speed operation (Patent pending) Motor vibration is created by magnetic flux variations of the motor, lower current from the drive due to back-emf from the motor at high speeds and lowering of phase voltages from the drive.

Ezi-STEP® drive detects these problems and the DSP adjusts the phase of the current according to the pole position of the motor, drastically suppressing vibration. This allows the smooth operation of the motor at high speeds.

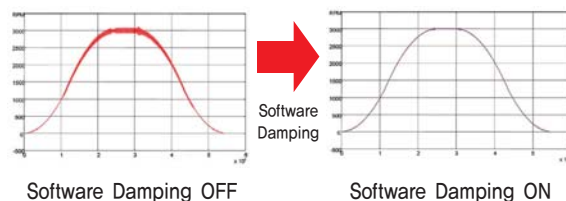

*This is real measured speed that using 100000[pulse/rev] encoder.

4 Drive Output Signal Monitoring

Ezi-STEP® provides loss of step, run/stop, over-current, over-heat, over-voltage, power, and motor connection alarms that can be monitored by the controller and visible by a motor-mounted flashing led indicator.

5 Improvement of High-Speed Driving

Depending on the speed of a stepping motor, Ezi-STEP® automatically increases the supply voltage and prevents the torque lowering due to the low operating voltage to the motor caused by back-emf voltage, this enables high-speed operation. Additionally, the software damping algorithm minimizes the vibration and prevents the loss-of-synchronization at high-speed.

Simple and Compact all-in-one Motor integrated with Drive

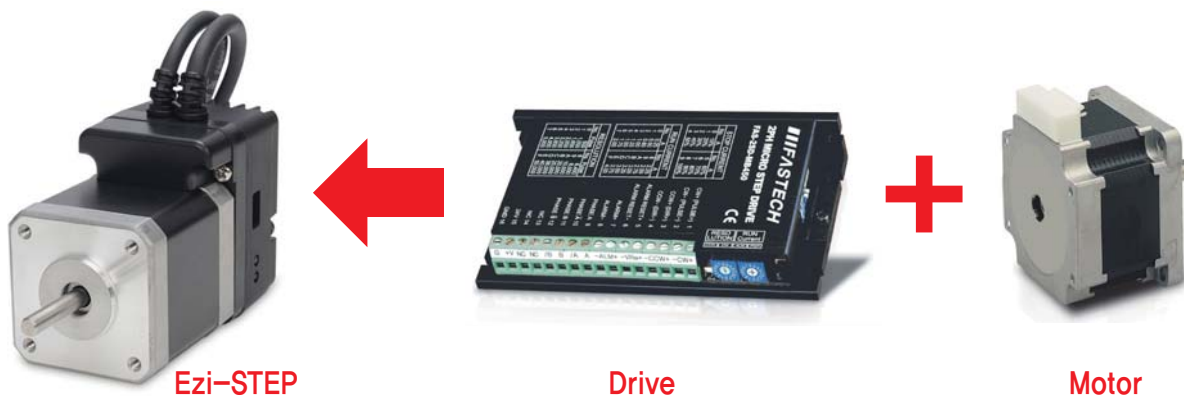

Saving installation space and ease of wiring by integrating drive circuits on the back side of a stepping motor.

● Ezi-STEP Part Numbering

Ezi-STEP-BT-42S-□

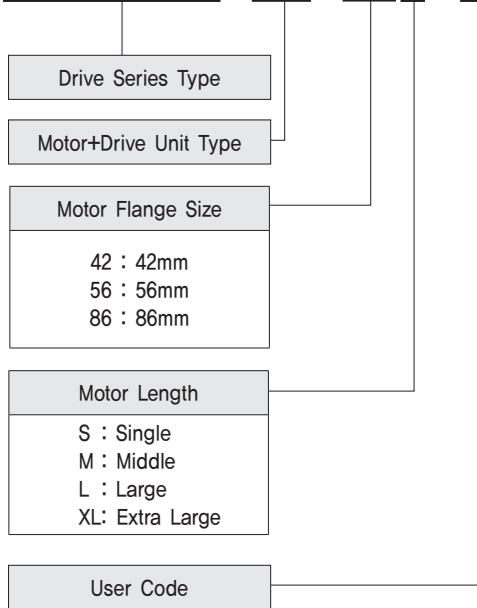

Part Number
Ezi-STEP-BT-42S
Ezi-STEP-BT-42M
Ezi-STEP-BT-42L
Ezi-STEP-BT-42X
Ezi-STEP-BT-56S
Ezi-STEP-BT-56M
Ezi-STEP-BT-56L
Ezi-STEP-BT-86M
Ezi-STEP-BT-86L
Ezi-STEP-BT-86XL

● Drive Specifications

Motor Model	BT-42 Series	BT-56 Series	BT-86 Series
Input Voltage	24VDC ±10%	24VDC ±10%	40~70VDC
Control Method	Bipolar PWM drive with 32bit DSP		
Current Consumption	Max : 500mA (Except motor current)		
Operating Condition	Ambient Temperature In Use : 0~50°C In Storage : -20~70°C		
	Humidity In Use : 35~85%RH (Non-Condensing) In Storage : 10~90%RH (Non-Condensing)		
	Vib, Resist. : 0.5G		
Function	Resolution(P/R) 500, 1000, 1600, 2000, 3200, 3600, 4000, 5000, 6400, 8000, 10000, 20000, 25000, 36000, 40000, 50000 (Set by DIP Switch) *Default : 10000		
	Max. Input Pulse Frequency 500KHz (Duty 50%)		
	Protection Functions Over current, Over speed, Step out, Over temperature, Over regenerated voltage, Motor connect error, Motor voltage error, System error, ROM error, Input voltage error (Identifiable which alarm is activated by counting the blinking times of status monitor LED)		
	LED Display Power Status(Green), Alarm Status(Red)		
	STOP Current 10%~100% (Set by RS-232C Communication) Be settled to set value of STOP Current after 0.1 second after motor stop. *Default : 50%		
	Pulse Input Method 1 Pulse / 2 Pulse (Set by RS-232C Communication) 1 Pulse: Pulse / Direction, 2 Pulse: CW / CCW *Default : 2 Pulse		
	Rotational Direction CW / CCW (Set by RS-232C Communication) Used when changing the direction of motor rotate. *Default : CW		
	Speed/Position Control Command Pulse train input (Photocoupler Input)		
I/O Signal	Input Signal Motor Free / Alarm Reset (Photocoupler Input)		
	Output Signal Alarm, Run/Stop (Photocoupler Output)		

● Motor Specifications [Ezi-STEP-BT-42 Series]

MODEL		UNIT	BT-42S	BT-42M	BT-42L	BT-42XL
DRIVE METHOD		----	BI-POLAR	BI-POLAR	BI-POLAR	BI-POLAR
NUMBER OF PHASES		----	2	2	2	2
VOLTAGE		VDC	3.36	4.32	4.56	7.2
CURRENT per PHASE		A	1.2	1.2	1.2	1.2
RESISTANCE per PHASE		Ohm	2.8	3.6	3.8	6
INDUCTANCE per PHASE		mH	2.5	7.2	8	15.6
HOLDING TORQUE		N · m	0.32	0.44	0.5	0.65
ROTOR INERTIA		g · cm ²	35	54	77	114
WEIGHTS		g	220	280	350	500
LENGTH (L)		mm	33	39	47	59
ALLOWABLE OVERHUNG LOAD (DISTANCE FROM END OF SHAFT)	3mm	N	22	22	22	22
	8mm		26	26	26	26
	13mm		33	33	33	33
	18mm		46	46	46	46
ALLOWABLE THRUST LOAD		N	Lower than motor weight			
INSULATION RESISTANCE		MOhm	100min. (at 500VDC)			
INSULATION CLASS		----	CLASS B (130°C)			
OPERATING TEMPERATURE		°C	0 to 55			

● Motor Dimension [mm] and Torque Characteristics

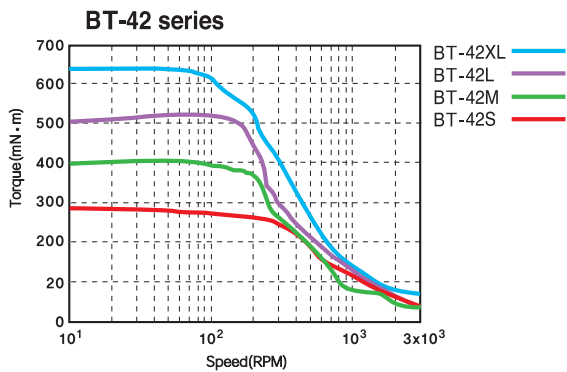
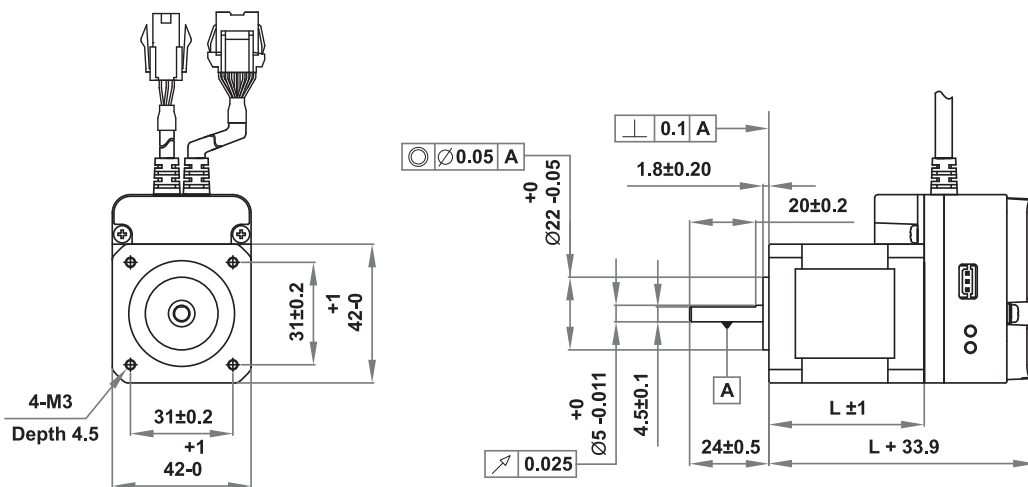

※ Measured Condition

Motor Voltage = 24VDC
 Motor Current = Rated Current (Refer to Motor Specification)
 Drive = Ezi-STEP-BT

● Motor Specifications [Ezi-STEP-BT-56 Series]

MODEL		UNIT	BT-56S	BT-56M	BT-56L
DRIVE METHOD		----	BI-POLAR	BI-POLAR	BI-POLAR
NUMBER OF PHASES		----	2	2	2
VOLTAGE		VDC	1.56	2.1	2.7
CURRENT per PHASE		A	3	3	3
RESISTANCE per PHASE		Ohm	0.52	0.54	0.9
INDUCTANCE per PHASE		mH	1	2	3.8
HOLDING TORQUE		N · m	0.64	1	1.5
ROTOR INERTIA		g · cm ²	120	200	480
WEIGHTS		g	500	700	1150
LENGTH (L)		mm	46	54	80
ALLOWABLE OVERHUNG LOAD (DISTANCE FROM END OF SHAFT)	3mm	N	52	52	52
	8mm		65	65	65
	13mm		85	85	85
	18mm		123	123	123
ALLOWABLE THRUST LOAD		N	Lower than motor weight		
INSULATION RESISTANCE		MOhm	100min, (at 500VDC)		
INSULATION CLASS		----	CLASS B (130°C)		
OPERATING TEMPERATURE		°C	0 to 55		

● Motor Dimension [mm] and Torque Characteristics

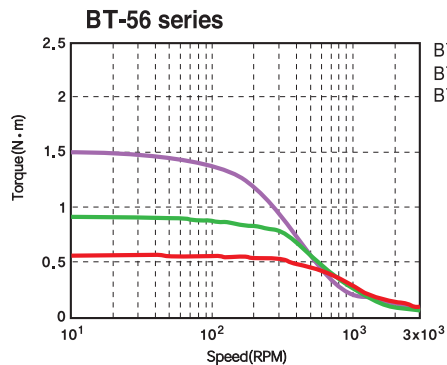
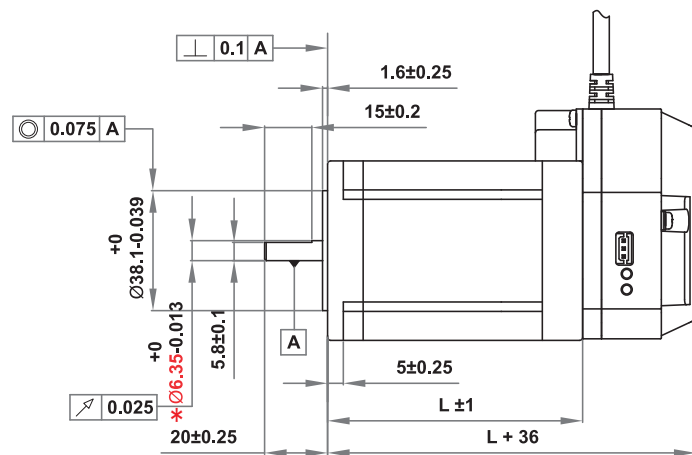
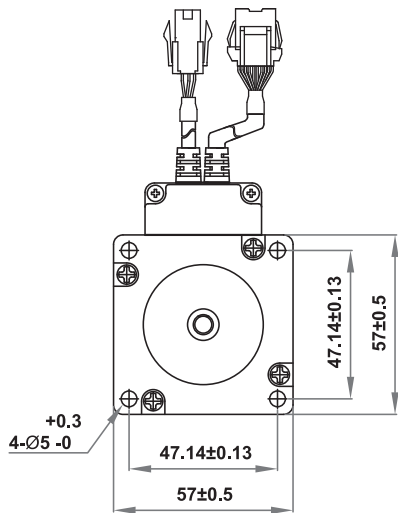

※ Measured Condition

Motor Voltage = 24VDC
 Motor Current = Rated Current (Refer to Motor Specification)
 Drive = Ezi-STEP-BT

* : There are 2 kinds size of front shaft diameter for BT-56 series as $\Phi 6.35$ and $\Phi 8.0$.

● Motor Specifications [Ezi-STEP-BT-86 Series]

MODEL		UNIT	BT-86M	BT-86L	BT-86XL
DRIVE METHOD		----	BI-POLAR	BI-POLAR	BI-POLAR
NUMBER OF PHASES		----	2	2	2
VOLTAGE		VDC	2.4	3.6	4.38
CURRENT per PHASE		A	6	6	6
RESISTANCE per PHASE		Ohm	0.4	0.6	0.73
INDUCTANCE per PHASE		mH	3.5	6.5	8.68
HOLDING TORQUE		N · m	4.0	7.5	9.0
ROTOR INERTIA		g · cm ²	1400	2700	4000
WEIGHTS		Kg	2.3	3.8	5.3
LENGTH (L)		mm	79	117	155
ALLOWABLE OVERHUNG LOAD (DISTANCE FROM END OF SHAFT)	3mm	N	270	270	270
	8mm		300	300	300
	13mm		350	350	350
	18mm		400	400	400
ALLOWABLE THRUST LOAD		N	Lower than motor weight		
INSULATION RESISTANCE		MOhm	100min, (at 500VDC)		
INSULATION CLASS		----	CLASS B (130°C)		
OPERATING TEMPERATURE		°C	0 to 55		

● Motor Dimension [mm] and Torque Characteristics

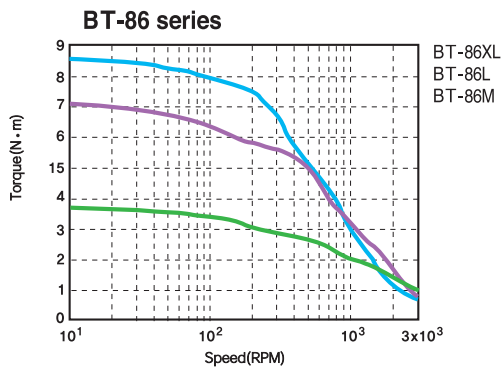
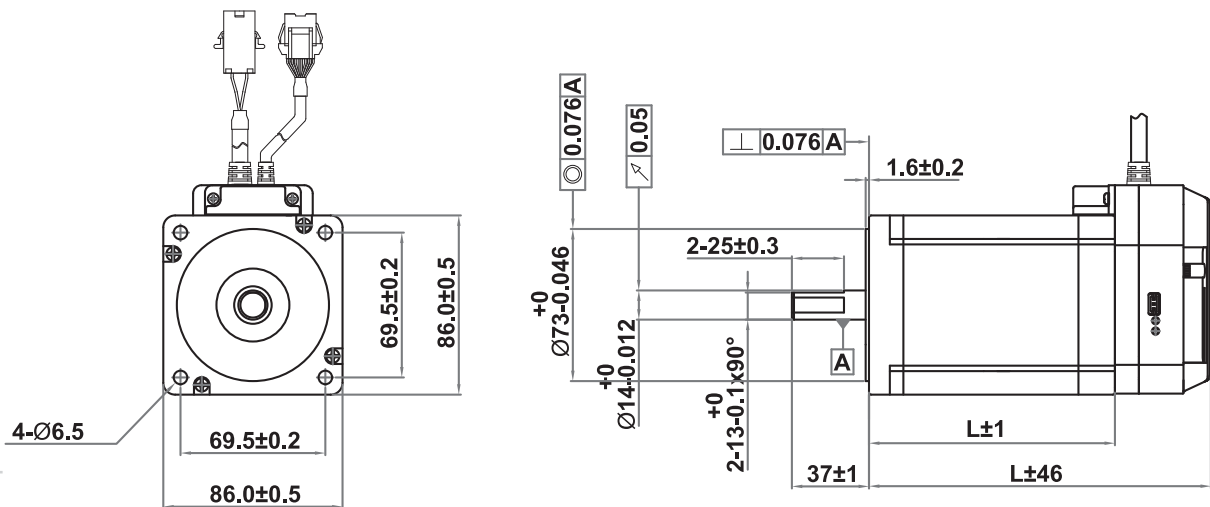

※ Measured Condition

Motor Voltage = 70VDC
 Motor Current = Rated Current(Refer to Motor Specification)
 Drive = Ezi-STEP-BT

● System Configuration

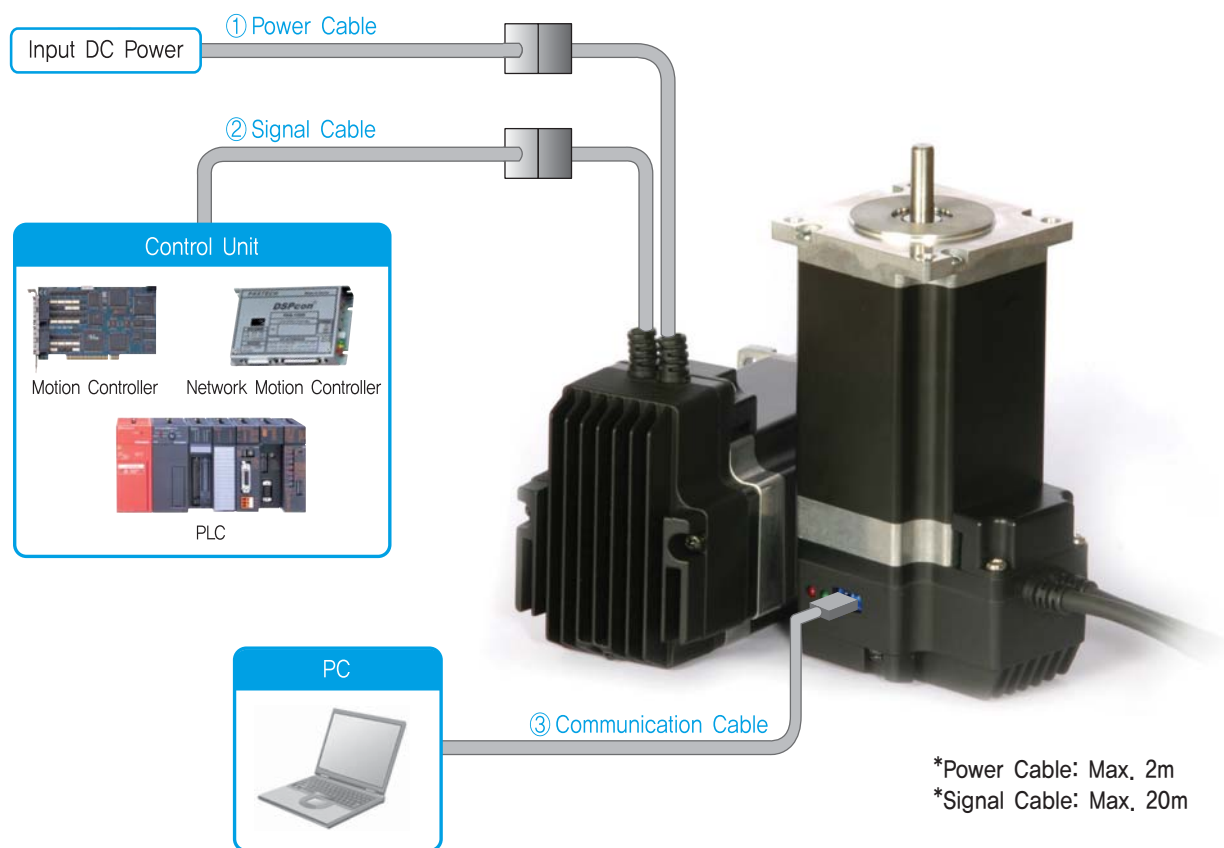

● Option

① Power Cable

Available to connect power of Ezi-STEP-BT.

Item	Length[m]	Remark
CBTS-P-□□□F	□□□	Normal Cable
CBTS-P-□□□M	□□□	Robot Cable
CBTL-P-□□□F	□□□	Normal Cable for BT-86
CBTL-P-□□□M	□□□	Robot Cable for BT-86

□ is for Cable Length. The unit is 1m and Max, 2m length.

② Signal Cable

Available to connect between Control System and Ezi-STEP-BT.

Item	Length[m]	Remark
CBTS-S-□□□F	□□□	Normal Cable
CBTS-S-□□□M	□□□	Robot Cable

□ is for Cable Length. The unit is 1m and Max, 20m length.

③ Communication Cable

Available to connect between PC and Ezi-STEP-BT. This is used for change setting value of Resolution and Stop Current etc.

Item	Length[m]	Remark
CBTS-C-□□□F	□□□	Normal Cable

□ is for Cable Length. The unit is 1m and Max, 15m length.

External Wiring

Ezi-STEP-BT-42/56 Series

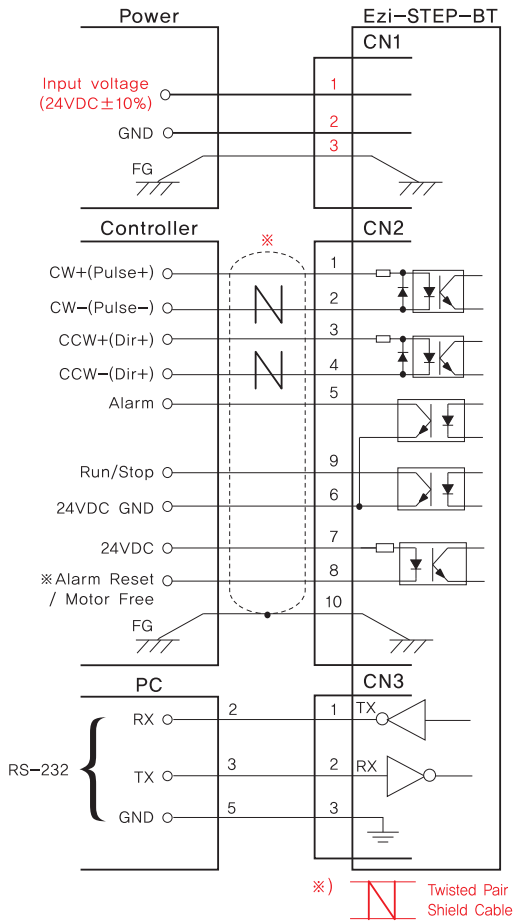

* Alarm Rest signal line is also used for Motor FREE signal.
(For details, please refer to the section for Control Input/Output signal)

Ezi-STEP-BT-86 Series

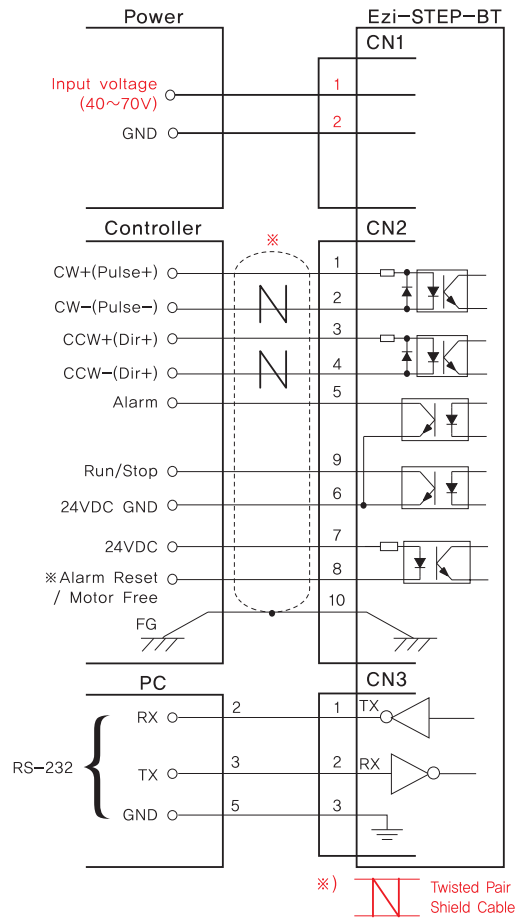

* Alarm Rest signal line is also used for Motor FREE signal.
(For details, please refer to the section for Control Input/Output signal)

Ezi-STEP-BT Series Connector

Power Connector(CN1)

NO.	Function
1	+24VDC
2	GND
3	Frame Ground
4	NC

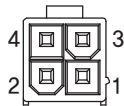

※ Only for BT-42, BT-56 Series.

Power Connector(CN1)

NO.	Function
1	40~70VDC
2	GND

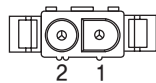

※ Only for BT-86 Series.

Signal Connector(CN2)

NO.	Function	I/O
1	CW+(PULSE+)	Input
2	CW-(PULSE-)	Input
3	CCW+(DIR+)	Input
4	CCW-(DIR-)	Input
5	ALARM	Output
6	GND	Input
7	+24VDC	Input
8	ALARM RESET	Input
9	RUN/STOP	Output
10	Frame Ground	----

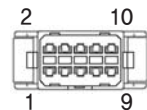

Communication Connector(CN3)

NO.	Function	I/O
1	Tx	Output
2	Rx	Input
3	GND	----

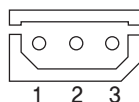

Control signal Input/Output Description

1 Input Signals

Input signals of the drive are all photocoupler inputs. The signal shows the status of internal photocouplers [ON: conduction], [OFF: Non-conduction], not displaying the voltage levels of the signal.

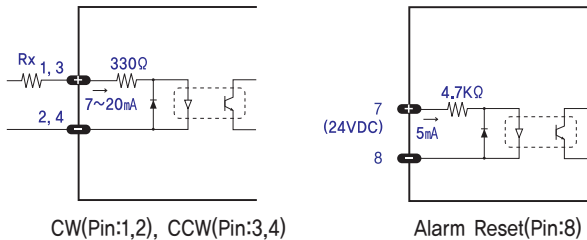

◆ CW, CCW Input

This signal can be used to receive a positioning pulse command from a user-side host motion controller. A user can select 1-pulse input mode or 2-pulse input mode. The input schematic of CW, CCW is designed for 5V TTL level. When using 5V level as an input signal, the resistor Rx is used and connect to the drive directly. When the level of input signal is more than 5V, have to add Rx. If this resistor is absent, the inner schematic can be broken. In input signal level is 12V case, Rx value is 2.2Kohm and in 24V case, 4.7Kohm is suitable for Rx value.

◆ Motor Free Input

This input can be used only to adjust the position by manually moving the motor shaft from the load-side. By setting the signal [ON], the drive cuts off the power supply to the motor. Then, one can manually adjust output position. When setting the signal back to [OFF], the drive resumes the power supply to the motor and recovers the holding torque. When driving a motor, one needs to set the signal [OFF]. In normal operations set the signal [OFF] or disconnect a wire to the signal.

◆ Alarm Reset Input

When a protection mode has been activated, a signal to this Alarm Reset input cancels the Alarm output. By setting the alarm reset input signal [ON], cancel Alarm output. Before cancel the Alarm output, have to remove the source of alarm.

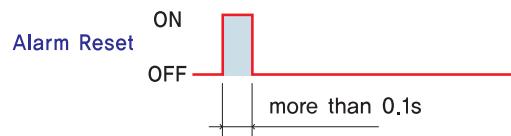

[Caution] If Alarm Reset input signal still remains [ON], motor will be Free state. Keep in mind to change [ON]→[OFF] state. It operates reversely compare to Normal mode, when you set inverse mode.

2 Output Signals

As the output signal from the drive, there are the photocoupler outputs(Alarm, Run/Stop). The signal status operate as [ON: conduction], [OFF: Non-conduction] of photocoupler not as the voltage level of signal.

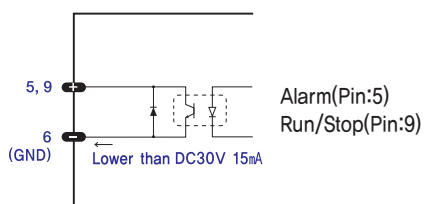

◆ Run/Stop Output

Run/Stop Output state is [ON] when motor positioning is completed. It operates reversely compare to Normal mode, when you set Inverse mode.

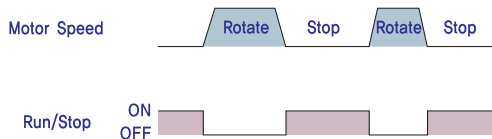

It operates reversely compare to Normal mode, when you set Inverse mode.

◆ Alarm Output

The Alarm output indicates [OFF] when the drive is in a normal operation. If a protection mode has been activated, it goes [ON]. A host controller needs to detect this signal and stop sending a motor driving command. When the drive detects an abnormal operation such as overload or overcurrent of a motor, it sets the Alarm output to [ON], flash the Alarm LED, disconnects the power to a motor, and stops the motor, simultaneously.

FASTECH Ezi-STEP BT



FASTECH Co., Ltd.

Rm #1202, Bucheon Technopark 401 Dong, Yakdea-dong,
Wonmi-Gu, Bucheon-si, Gyeonggi-do, Rep. Of Korea (Zip)420-734
TEL : 82-32-234-6300,6301 FAX : 82-32-234-6302
E-mail : daniel@fastech.co.kr website: www.fastech.co.kr

FASTECH AMERICA LLC

811 E Plano Parkway, Suite 110A, Plano, TX 75074 USA
Toll Free: 877-905-4428 972-218-0210
Email: support@fastechamerica.com
website: www.fastechamerica.com